

DECLASSIFIED

BY GIUCY GIUCE



Between Worlds Quilt
designed by:
Giucy Giuce

Quilt Size: **72" x 72"**

andoverfabrics.com

About DECLASSIFIED

Look up. Are those mysterious lights in the sky just an airplane?
Or something more? Redacted documents. Mysterious shapes in
fields. Peculiar, archaic symbols. The truth is out there. We just
need to dig a little deeper to find it... – Giucy Giuce

andover



makower.uk

Free Pattern Download Available

1384 Broadway New York, NY 10018
Tel. (800) 223-5678 • andoverfabrics.com

Between Worlds Quilt



Introducing Andover Fabrics new collection: SPECTRASTATIC by Giucy Giuce

Quilt designed by Giucy Giuce

Quilt finishes 72" x 72"
24 Blocks: 6" x 6"
112 Flying Geese: 2" x 4"

This medallion-style quilt would look stunning on a wall or as a topper. The unique prints will appeal to anyone interested in engineering, science, space travel, or UFO phenomenon.

Cutting Directions

Note: Read assembly directions before cutting patches. All measurements are cut sizes and include ¼" seam allowances. A fat ⅛ is a 9" x 20"-22" cut of fabric. A fat ¼ is a 18" x 20"-22" cut of fabric. Mitered borders include extra length for insurance. WOF designates the width of fabric from selvedge to selvedge (approximately 42" wide).

Fabric A

Fussy-cut (4) borders 4½" x 48½", cut lengthwise

Fabric B

Cut (4) Template 1 (T1)

Fabric C

Cut (4) squares 4½"

Fabric D

Cut (112) squares 2½"

Fabric E

Cut (4) rectangles 6½" x 12½"

Cut (4) squares 6½"

Cut (12) T2

Fabric F

Cut (12) T1

Fabric G

Cut (12) T2

Cut (112) squares 2½"

Fabric H

Cut (20) rectangles 2½" x 4½"

Fabric I

Cut (8) strips 4½" x WOF, pieced to make the following:
(4) borders 4½" x 74"

Fabric Requirements

		Yardage	Fabric
Fabric A	border	1½ yards	9242-B
Fabric B	blocks	fat ¼ yard	9242-P
Fabric C	border corner	fat ⅛ yard	9243-T
Fabric D	flying geese	⅝ yard	9244-K
Fabric E	background	1 yard	9244-L
Fabric F	blocks	½ yard	9245-B
Fabric G	blocks	1¼ yards	9245-K
Fabric H	flying geese	fat ¼ yard	9247-G
Fabric I	border	1¼ yards	9247-P
*Fabric J	blocks	1 yard	9069-B
Fabric K	border corner	fat ¼ yard	9069-T
3 Limes	flying geese	⅜ yard ea.	
		9243-G	9245-G 9246-Y
2 Blues	border	⅜ yard ea.	
		9243-GL	9247-T
2 Fat ¼s	border	fat ¼ yard ea.	
		9246-G	9246-T
Backing		4¾ yards	9242-L

*includes binding

Also needed: 6½" or larger acrylic ruler

Fabric J

Cut (8) strips 2½" x WOF for binding

Cut (8) T1

Fabric K

Cut (4) squares 6½"

3 Limes

From each:

Cut (30-31) rectangles 2½" x 4½" (92 total)

From 1: Cut (4) squares 4½"

2 Blues

From each:

Cut (24) rectangles 2½" x 6½"

2 Fat 1/4s

From each:

Cut (12) rectangles 2½" x 6½"

Backing

Cut (2) panels 40" x 80", pieced to fit quilt top
with overlap on all sides

Between Worlds Quilt

Making the Quilt

1. Conserve fabric by cutting Template 2 patches as shown in the cutting Diagram 1. Make acrylic templates of T1 and T2, including the dots. Poke holes through the template at each dot with an ice pick. Mark the dots on the back side of fabric patches. Pin a T2 patch on top of a T1, matching dots and ends. Pin every inch or so along the curve. Stitch in a $\frac{1}{4}$ " seam allowance. Press seam allowances toward T1. Trim each block to $6\frac{1}{2}$ " square: position the $6\frac{1}{2}$ " mark of the acrylic ruler on the corner of T1 as shown in Diagram 2. Trim T2 along the opposite edges. Be sure that a $\frac{1}{4}$ " seam allowance remains beyond the T1/T2 seam. Referring to the quilt diagram for fabric combinations, make 24 blocks.
2. Referring to the Quilt Diagram, arrange the blocks and Fabric E patches in 6 rows. Join the rows.
3. Join the $2\frac{1}{2}$ " x $6\frac{1}{2}$ " strips to make 12 Unit 1 and 12 Unit 2 (Diagram 3). Arrange the units around the quilt in the order shown. Join 3 Unit 1 and 3 Unit 2 to make a border. Make 4 borders. Sew to the sides of the quilt. Sew Fabric K squares to ends of 2 borders. Sew to the top and bottom.
4. Sew Fabric A borders to the sides. Join Fabric C squares to ends of remaining borders. Sew to the top and bottom.
5. **Flying Geese:** Draw a diagonal line on the wrong side of each Fabric G $2\frac{1}{2}$ " square. Hint: After making a few Flying Geese, you may feel confident enough to eliminate the diagonal line and stitch the squares "by eye". Place a marked square on one end of a lime $2\frac{1}{2}$ " x $4\frac{1}{2}$ " rectangle, right sides together. Sew on the marked line; trim away and discard excess fabric (Diagram 4). Press open. Repeat this process on the opposite end of the rectangle (Diagram 5) to make a Flying Geese Unit. Make 112 total.
6. Referring to the Quilt Diagram, arrange 28 Flying Geese on each side of the quilt, noting change of direction in the center of each border. Once you are satisfied with the color arrangement, join the geese to make 4 borders. Sew to the sides of the quilt. Join a lime $4\frac{1}{2}$ " square to ends of remaining borders. Sew to the top and bottom.
7. Sew Fabric I borders to the quilt, starting and stopping stitching $\frac{1}{4}$ " from the quilt's raw edge. Miter the corners and trim the excess.

Finishing the Quilt

8. Layer the quilt with batting and backing and baste. Quilt in the ditch around borders and block patches. Quilt curved block patches and outer border as you wish. Quilt around the printed motif in Fabric A border. Bind to finish the quilt.

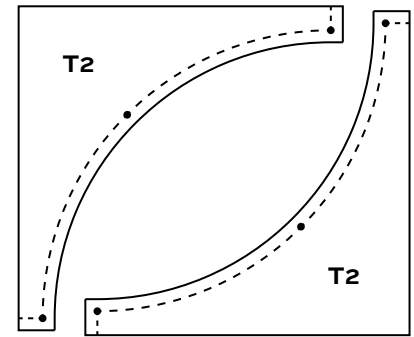

Cutting – Diagram 1

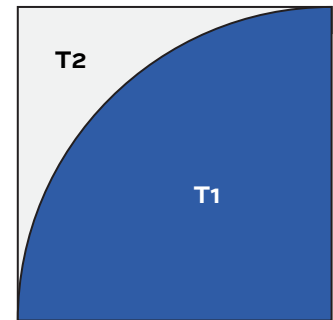

Block – Make 24

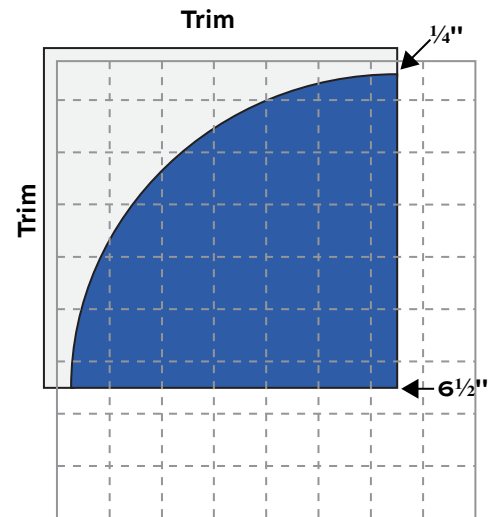

Trimming Block – Diagram 2

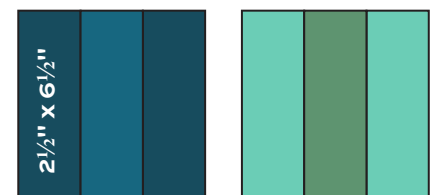

Unit 1 – Make 12 Unit 2 – Make 12

Diagram 3

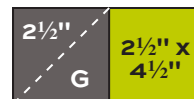

Diagram 4



Diagram 5



Flying Geese
Make 112

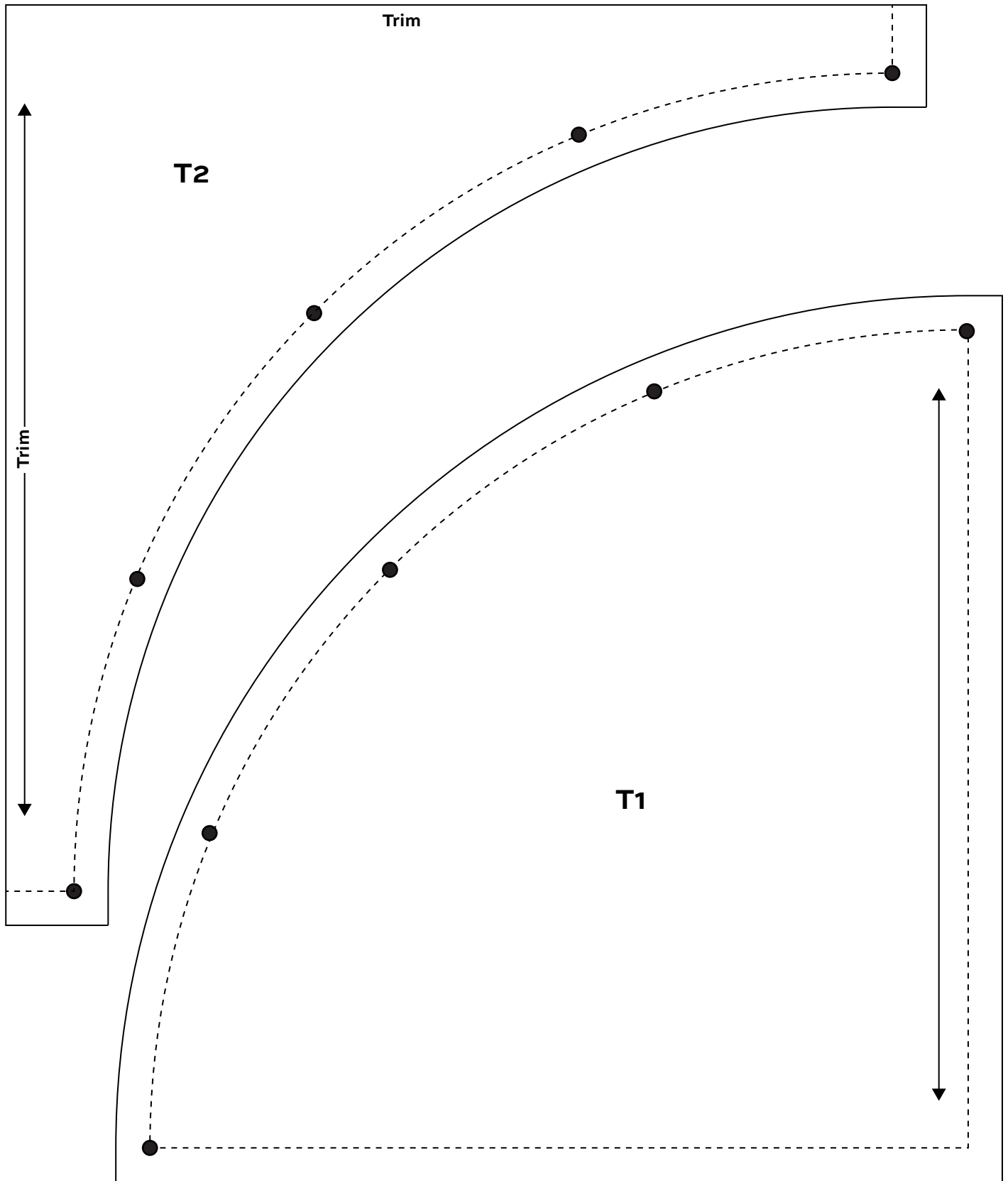

Between Worlds Quilt

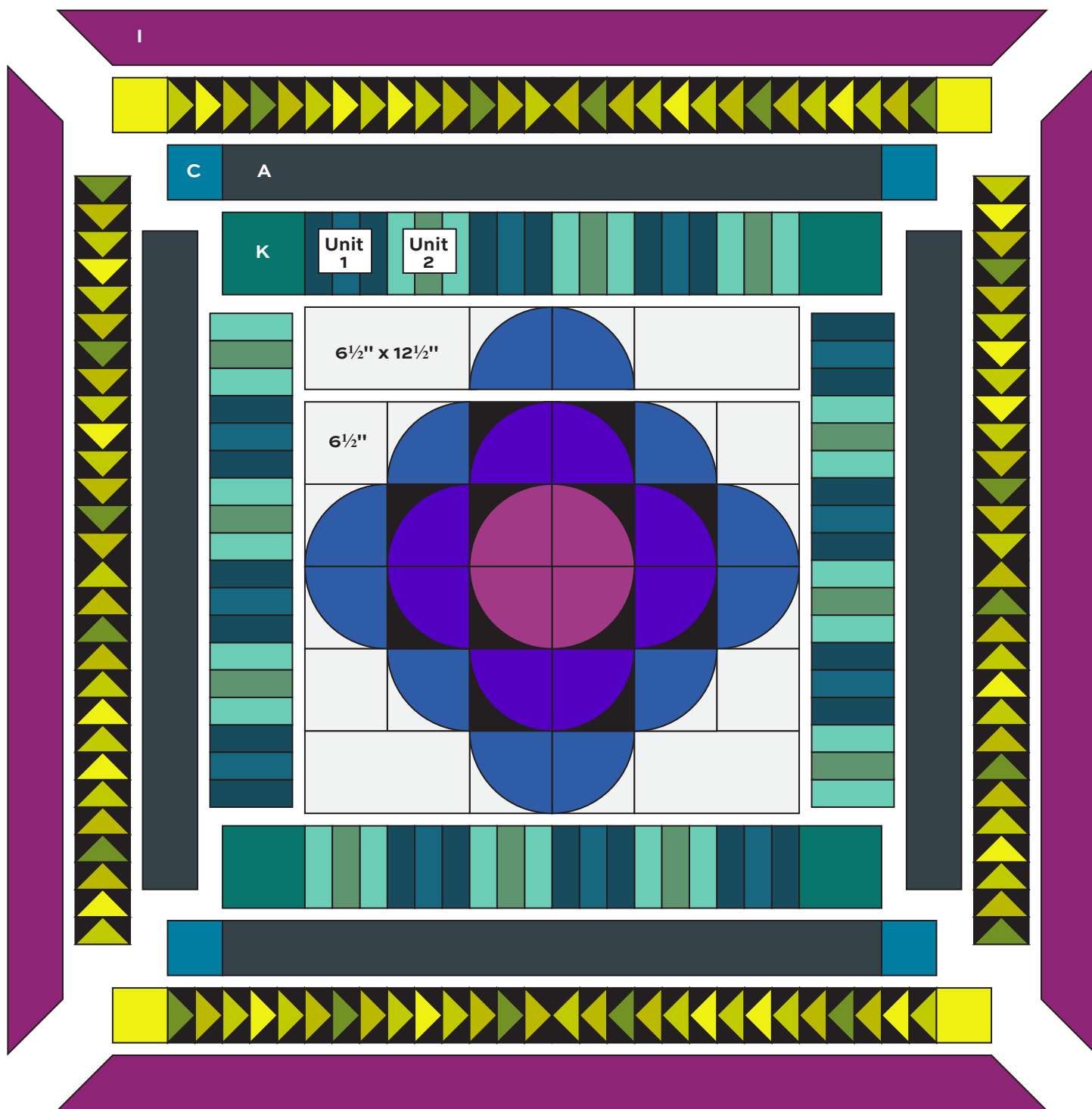

Quilt Diagram

DECLASSIFIED

BY GIUCY GIUCE



9242-B*

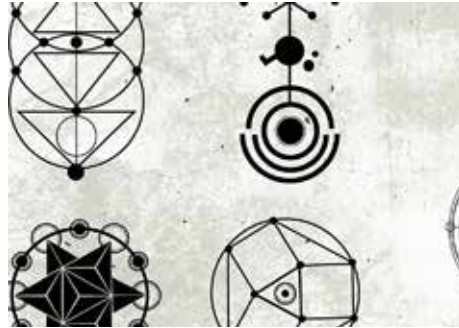

9242-L*

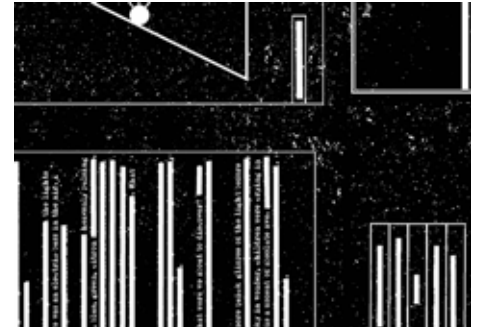

9244-K*



9242-C



9242-P*



9244-L*

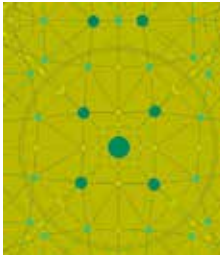

9243-G*



9243-GL*

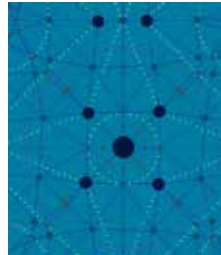

9243-T*



9245-B*



9245-G*

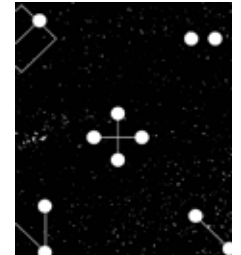

9245-K*



9246-B



9246-G*

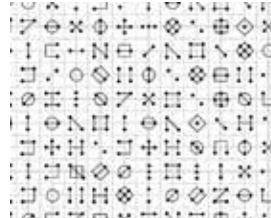

9246-L



9246-T*

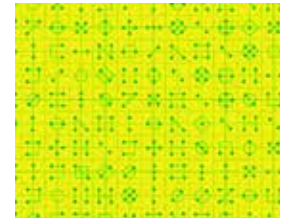

9246-Y*



9247-G*



9247-P*



9247-T*



9069-B*



9069-T*

*Indicates fabrics used in quilt pattern. Fabrics shown are 25% of actual size.

andover : makower uk

Free Pattern Download Available

1384 Broadway New York, NY 10018
Tel. (800) 223-5678 • andoverfabrics.com